



■ Features

- 3 ψ 3-wire / Δ 196~305VAC or 3 ψ 4-wire / Y 340~530VAC wide input range
- Built-in active PFC function
- High efficiency up to 91%
- Protections: Short circuit / Overload / Over voltage / Over temperature / Fan fail
- Forced air cooling by built-in fan with speed control function
- Output voltage can be trimmed between 20~120% by 1~6VDC external control signal
- Output current can be trimmed between 20~100% by 1~5VDC external control signal
- Current sharing up to 2 units
- Alarm signal output (relay contact and open collector signal): AC fail, DC OK, fan fail, OTP
- Built-in 12V/0.1A auxiliary output for remote control
- Built-in remote ON/OFF control
- Built-in remote sense function
- 5 years warranty

■ Applications

- Industrial control equipments
- Automation equipments
- Laser engravers
- Telecommunication systems

■ Description

RST-10000 is one 10000W single output enclosed type AC/DC power supply series. This series accepts the wide range 3-phase AC input (3 ψ 3-wire / Δ 196~305VAC or 3 ψ 4-wire / Y 340~530VAC) and supplies 24VDC, 36VDC and 48VDC at the output. RST-10000 particularly provides the wide range adjustment function for output voltage and current by means of an external control signal; moreover, RST-10000 offers two overload protection mechanisms, the “continuous constant current limiting” mode and the “constant current limiting with delay shutdown after 5 seconds” mode, well providing the flexibility for high power system design.

RST-10000 has the built-in active PFC function and the working efficiency is high up to 91%. With the built-in fan, the entire series can supply the full load output under 50°C ambient temperature. The parallel function is built to transmit an even higher power with up to 2 units. Other functions include the remote sense function, the 12V/0.1A auxiliary power, the alarm signal output (both relay contact and open collector signal) for AC fail, DC OK, fan fail and over temperature protection, and etc. RST-10000 series acquires the major global safety regulation certificates.

■ Model Encoding

RST - 10000- 24

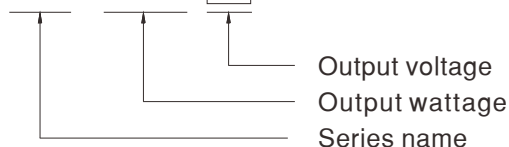



SPECIFICATION

| MODEL | | RST-10000-24 | RST-10000-36 | RST-10000-48 |
|-----------------------|--|--|----------------------------|---------------------------------|
| OUTPUT | DC VOLTAGE | 24V | 36V | 48V |
| | RATED CURRENT | 400A | 276A | 210A |
| | CURRENT RANGE | 0 ~ 400A | 0 ~ 276A | 0 ~ 210A |
| | RATED POWER | 9600W | 9936W | 10080W |
| | RIPPLE & NOISE (max.) Note.2 | 150mVp-p | 200mVp-p | 200mVp-p |
| | VOLTAGE ADJ. RANGE Note.4 | 23.5 ~ 28.8V | 35 ~ 43.2V | 47 ~ 57.6V |
| | VOLTAGE TOLERANCE Note.3 | ±1.0% | ±1.0% | ±1.0% |
| | LINE REGULATION | ±0.5% | ±0.5% | ±0.5% |
| | LOAD REGULATION | ±0.5% | ±0.5% | ±0.5% |
| | SETUP, RISE TIME | 2200ms, 80ms at full load | | |
| HOLD UP TIME (Typ.) | 20ms / 230VAC at 75% load | | 14ms / 230VAC at full load | |
| INPUT | VOLTAGE RANGE | 3 ϕ 3-wire / Δ 196 ~ 305VAC or 3 ϕ 4-wire / Y 340 ~ 530VAC | | |
| | FREQUENCY RANGE | 47 ~ 63Hz | | |
| | POWER FACTOR (Typ.) | 0.95/230VAC(400VAC) at full load | | |
| | EFFICIENCY (Typ.) | 89% | 90% | 91% |
| | AC CURRENT (Typ.) | 30A/230VAC(3 ϕ 3-wire / Δ) | | 18A/400VAC(3 ϕ 4-wire / Y) |
| | INRUSH CURRENT (Typ.) | 100A/ Δ 230VAC(Y 400VAC) | | |
| | LEAKAGE CURRENT | <7mA / Δ 305VAC(Y 530VAC) | | |
| PROTECTION | OVERLOAD | 100 ~ 112% rated output power User adjustable continuous constant current limiting or constant current limiting with delay shutdown after 5 seconds, re-power on to recover | | |
| | OVER VOLTAGE | 30 ~ 33.6V | 45 ~ 50.4V | 60 ~ 67.2V |
| | OVER TEMPERATURE | Shut down o/p voltage, recovers automatically after temperature goes down | | |
| | | Protection type : Shut down o/p voltage, re-power on to recover | | |
| FUNCTION | AUXILIARY POWER(AUX) | 12V@0.1A(Only for Remote ON/OFF control) | | |
| | REMOTE ON/OFF CONTROL | Please refer to the Function Manual | | |
| | ALARM SIGNAL OUTPUT | Please refer to the Function Manual | | |
| | OUTPUT VOLTAGE TRIMMING | Adjustment of output voltage is allowable between 20 ~ 120% by 1 ~ 6VDC external control signal | | |
| | OUTPUT CURRENT TRIMMING | Adjustment of output current is allowable between 20 ~ 100% by 1 ~ 5VDC external control signal | | |
| | CURRENT SHARING | Please refer to the Function Manual | | |
| ENVIRONMENT | WORKING TEMP. | -30 ~ +70°C (Refer to "Derating Curve") | | |
| | WORKING HUMIDITY | 20 ~ 90% RH non-condensing | | |
| | STORAGE TEMP., HUMIDITY | -40 ~ +85°C, 10 ~ 95% RH | | |
| | TEMP. COEFFICIENT | ±0.03%/°C (0 ~ 50°C) | | |
| | VIBRATION | 10 ~ 500Hz, 2G 10min./1cycle, 60min. each along X, Y, Z axes | | |
| SAFETY & EMC (Note 6) | SAFETY STANDARDS | UL60950-1, TUV EN60950-1 approved | | |
| | WITHSTAND VOLTAGE Note.5 | I/P-O/P:3KVAC I/P-FG:2KVAC O/P-FG:0.5KVAC | | |
| | ISOLATION RESISTANCE Note.5 | I/P-O/P, I/P-FG, O/P-FG:100M Ohms / 500VDC / 25°C / 70% RH | | |
| | EMC EMISSION | Compliance to EN55022 (CISPR22) Class A, EN61000-3-2,-3 | | |
| | EMC IMMUNITY | Compliance to EN61000-4-2,3,4,5,6,8,11, EN55024, EN61000-6-2, heavy industry level, criteria A | | |
| OTHERS | MTBF | 18.7K hrs min. MIL-HDBK-217F (25°C) | | |
| | DIMENSION | 540*424*83.5mm (L*W*H) | | |
| | PACKING | 23.5Kg; 1pcs/23.5Kg/2.45CUFT | | |
| NOTE | <p>1. All parameters NOT specially mentioned are measured at Δ230VAC(Y 400VAC) input, rated load and 25°C of ambient temperature.</p> <p>2. Ripple & noise are measured at 20MHz of bandwidth by using a 12" twisted pair-wire terminated with a 0.1uf & 47uf parallel capacitor.</p> <p>3. Tolerance : includes set up tolerance, line regulation and load regulation.</p> <p>4. Adjusted through potentiometer.</p> <p>5. During withstandards voltage and isolation resistance testing, the screw "A" shall be temporarily removed, and shall be installed back after the testing.</p> <p>6. The power supply is considered a component which will be installed into a final equipment. The final equipment must be re-confirmed that it still meets EMC directives. For guidance on how to perform these EMC tests, please refer to EMI testing of component power supplies.</p> | | | |

■ Block Diagram

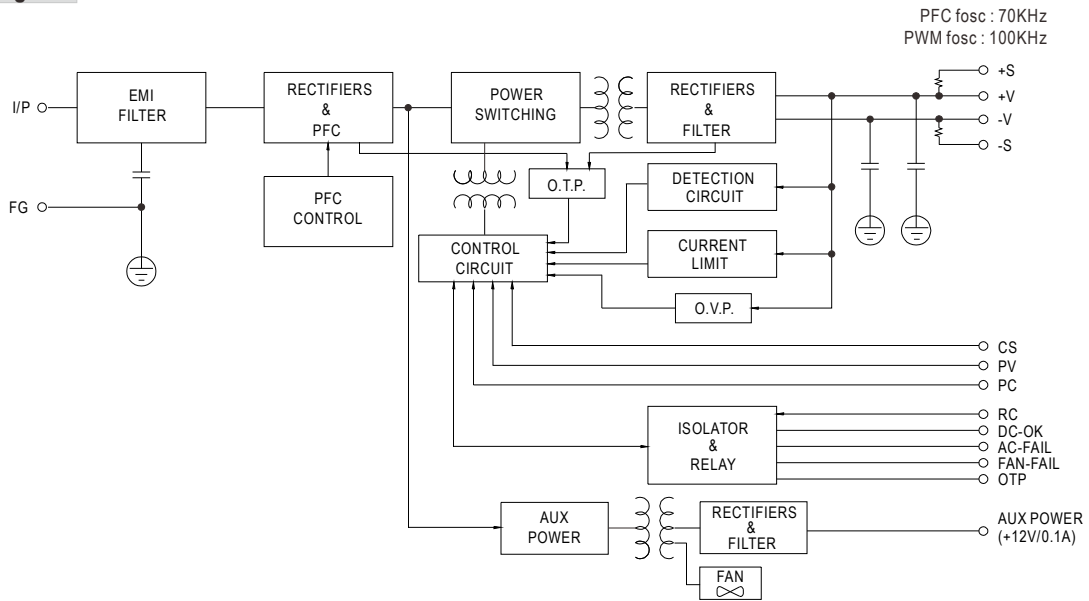

■ Derating Curve

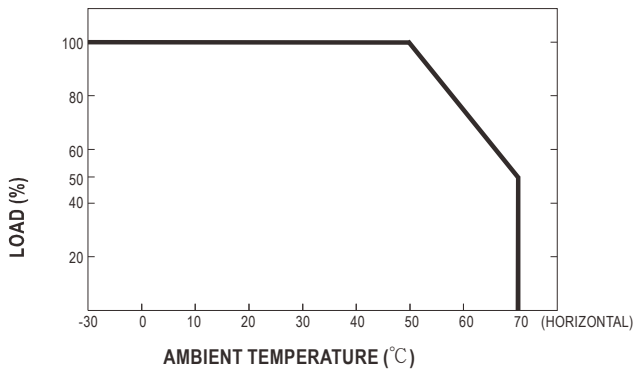

■ Static Characteristics

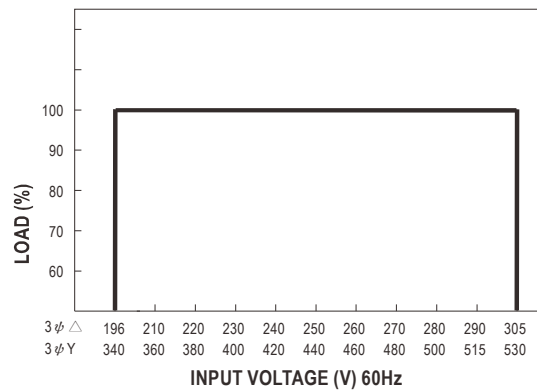

Function Description of CN992, 993

| Pin No. | Function | Description |
|---------|----------|---|
| 1 | CS- | Current sharing signal. When units are connected in parallel, the CS pins of the units should be connected to allow current balance between units. Please refer to the Function Manual section for details. |
| 2 | CS+ | |
| 3 | +S | The +S signal should be connected to the positive terminal of the load. The +S and -S leads should be twisted in pair to minimize noise pick-up effect. The maximum line drop compensation is 0.5V. |
| 5 | -S | |
| 4 | PV- | Connect to external DC voltage source for output voltage trimming. Output voltage can be trimmed between 20 ~ 120% of the rated output voltage. Please refer to the Function Manual section for details. |
| 6 | PV+ | |
| 7 | PC- | Connect to external DC voltage source for output current trimming. Output current can be trimmed between 20 ~ 100% of the rated output current. Please refer to the Function Manual section for details. |
| 9 | PC+ | |
| 8 | RC- | The output can be turned ON/OFF by the electrical signal between RC+ and RC-. Please refer to the Function Manual section for details. |
| 10 | RC+ | |

Function Description of CN991

| Pin No. | Function | Description |
|---------|---------------|---|
| 1 | 12V-AUX | Auxiliary voltage output, 11.4~12.6V, referenced to pin 3(GND-AUX). The maximum load current is 0.1A. This output is not controlled by the "Remote ON/OFF" function. |
| 2 | DC-OK2-GND | Alarm signal of DC-OK. Open collector signal. Low when the PSU turns on. The maximum sink current is 10mA and the maximum external voltage is 20V. |
| 4 | DC-OK2 | |
| 3 | GND-AUX | Auxiliary voltage output GND. The signal return is isolated from the output terminals (+V & -V). |
| 5 | +V | PSU output +V signal. |
| 6 | AC-FAIL2-GND | Alarm signal of AC fail. Open collector signal. Low when the PSU input voltage is too low. The maximum sink current is 10mA and the maximum external voltage is 20V. |
| 8 | AC-FAIL2 | |
| 7 | -V | PSU output -V signal. |
| 9 | OTP2 | Alarm signal of OTP. Open collector signal. Low when the PSU over temperature protection occurs. The maximum sink current is 10mA and the maximum external voltage is 20V. |
| 11 | OTP2-GND | |
| 10 | FAN-FAIL2 | Alarm signal of fan fail. Open collector signal. Low when the internal fan fails. The maximum sink current is 10mA and the maximum external voltage is 20V. |
| 12 | FAN-FAIL2-GND | |
| 13 | OTP1 | Alarm signal of OTP. Normally open contact. "Short" when the PSU over temperature protection occurs. Relay contact rating(maximum) is 30V/1A resistive. |
| 15 | OTP1-GND | |
| 14 | DC-OK1 | Alarm signal of DC-OK. Normally open contact. "Short" when the PSU turns on. Relay contact rating(maximum) is 30V/1A resistive. |
| 16 | DC-OK1-GND | |
| 17 | AC-FAIL1-GND | Alarm signal of AC-fail. Normally open contact. "Short" when the PSU input voltage is too low. Relay contact rating(maximum) is 30V/1A resistive. |
| 19 | AC-FAIL1 | |
| 18 | FAN-FAIL1-GND | Alarm signal of fan fail. Normally open contact. "Short" when the internal fan fails. Relay contact rating(maximum) is 30V/1A resistive. |
| 20 | FAN-FAIL1 | |

Function Manual

1.Remote ON/OFF Control

The PSU can be turned ON/OFF by using the "Remote ON/OFF" function.

| Between ON/OFF(CN992 or CN993 pin10) and 12V-AUX(CN991 pin1) | Output Status |
|--|---------------|
| SW close (Short) | PSU ON |
| SW open (Open) | PSU OFF |

Table 1.1

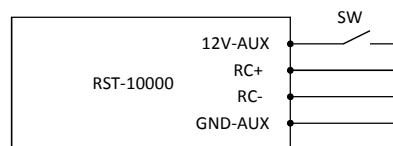

Fig 1.1

2.Remote Sense

The remote sense function compensates the voltage drop on the cable, between the PSU and the load, up to 0.3V. If the remote sense function is not required, +S and +V, as well as -S and -V, need to be connected to be free from noise and interference. (+S and +V, -S and -V are connected as factory default setting)

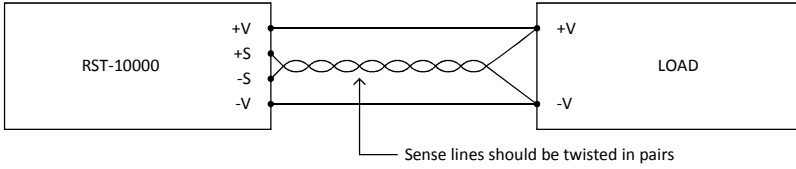



Fig 2.1

3.Select PV mode (Output Voltage Trimming)

(1)SVR mode

- (a)Have the DIP switch position-3 set as 
- (b)Output voltage can be trimmed by SVR.

(2)PV mode

- (a)Have the DIP switch position-3 set as 
- (b)Connect an external DC source between PV+ and PV- on CN992 or CN993.
- (c)+S and +V, as well as -S and -V, need to be connected as shown in Fig 3.1.
- (d)Trimming of output voltage is allowed between 20~120%(Typ.) of the rated output voltage as is shown in Fig 3.2.

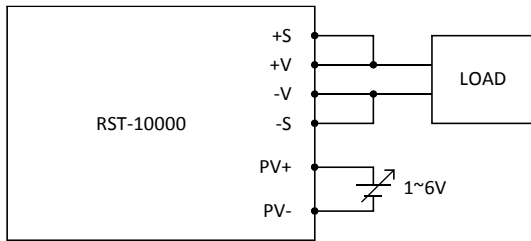

Fig 3.1

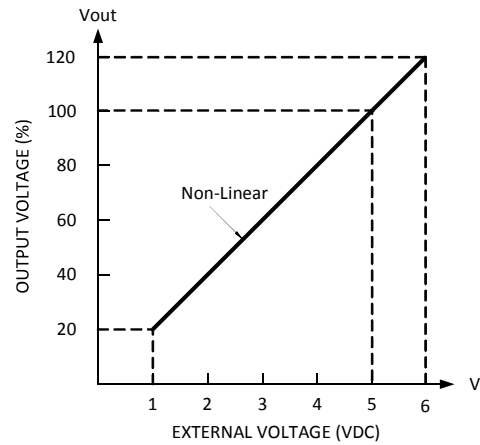



Fig 3.2

4.Select PC Mode (Output Current Trimming)

(1)Default OLP value

- (a)Have the DIP switch position-2 set as 
- (b)Output current is set default value.

(2)PC mode

- (a)Have the DIP switch position-2 set as 
- (b)Connect an external voltage source between PC+ and PC- on CN992 or CN993 as shown in Fig 4.1.
- (c)Trimming of output current is allowed between 20~ 100%(Typ.) of the rated output current as shown in Fig 4.2.

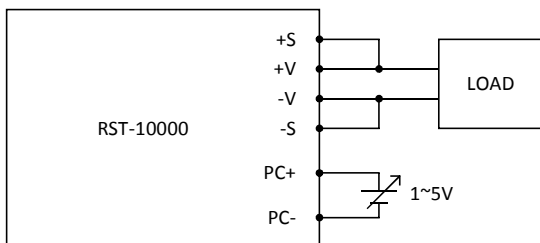

Fig 4.1

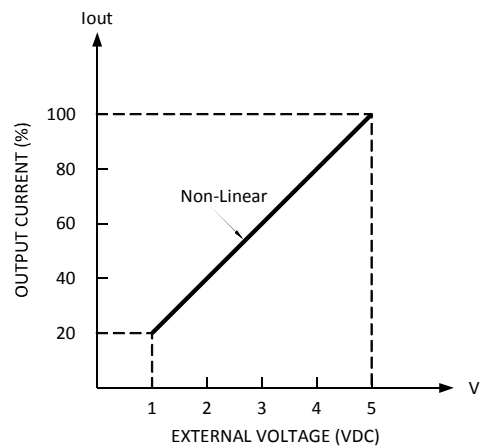



Fig 4.2

5. Select OLP Mode

(1) Continuous Constant Current mode

Have the DIP switch position-1 set as , and RST-10000 will work in continuous constant current mode when the output is overloaded or short-circuited.

(2) Delay Shutdown mode

Have the DIP switch position-1 set as , and RST-10000 will shut down after 5 seconds of constant current operation, when the output is overloaded or short-circuited.

6. Front Panel Indicators

| LED | Description |
|-------------|-----------------------------------|
| GREEN(LED1) | LED on when output voltage is OK |
| RED(LED2) | LED on when any protection occurs |

Table 6.1

7. Alarm Signal Output

There are 4 alarm signals on CN991, and each signal can select two types of output circuit.

(1) Relay contact output

Normally open contact. "Short" when the alarm arises. Relay contact rating(maximum) is 30V/1A resistive.

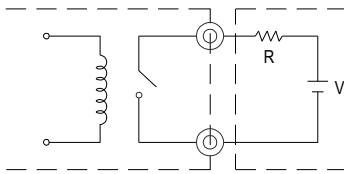

Fig 7.1

(2) Open collector output

An external voltage source is required for this function that is shown in Fig 7.2. These signals are isolated from output. The maximum sink current is 10mA and the maximum external voltage is 20V (there is a built-in 24V zener diode in inner circuitry).

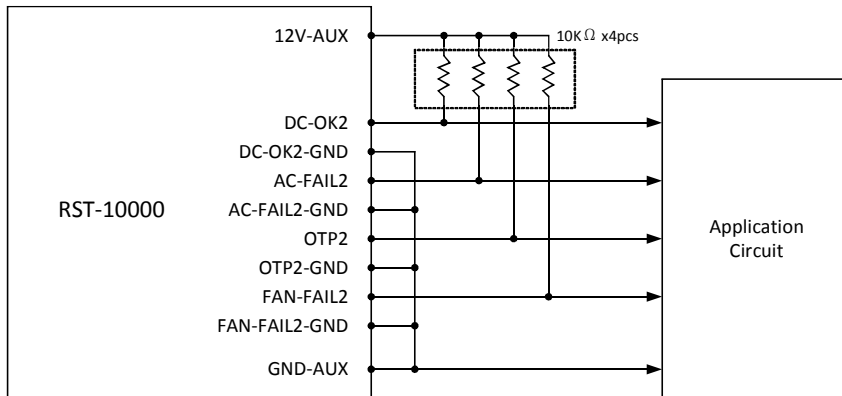
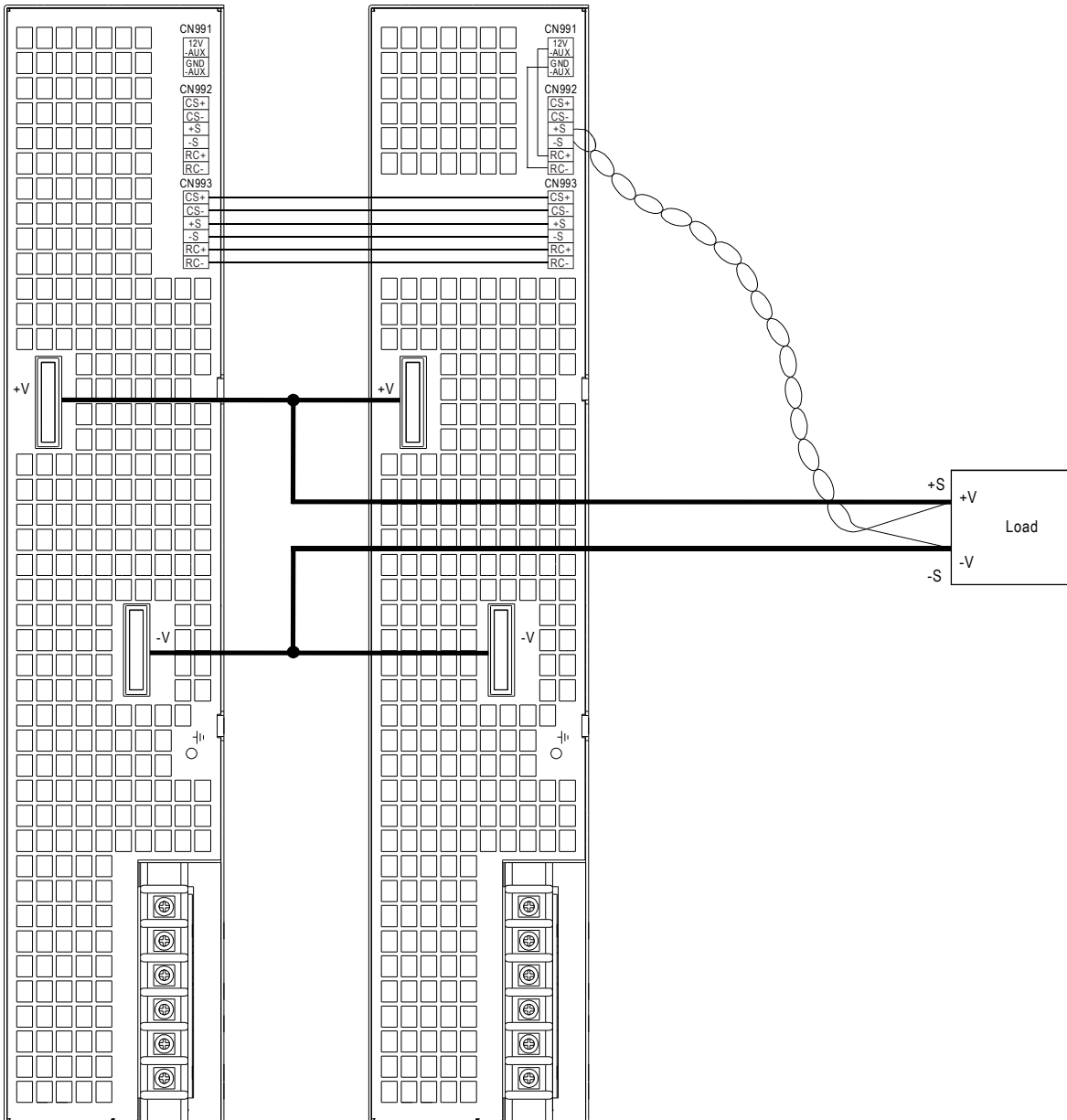

Fig 7.2

8.Current Sharing

- (1) Parallel operation is available by connecting the units shown as follows. (+S, -S and CS+, CS- and RC+, RC- are connected mutually in parallel.)
- (2) The voltage difference among each output should be minimized that less than 0.2V is required.
- (3) The total output current must not exceed the value determined by the following equation.
 (Output current at parallel operation)=(The rated current per unit)x(Number of unit)x0.9
- (4) In parallel operation 2 units is the maximum, please consult the manufacturer for other applications.
- (5) When the remote sense function is used in parallel operation, the sensing wire must be connected only to the master unit.
- (6) Wires of the remote sense function should be kept at least 30 cm from input wires.
- (7) When in parallel operation, the minimum output load should be greater than 5% of the total output load.
 (Min. Load) > (5% rated current per unit) x (number of unit)



9.AC Power Connection

©3 ϕ 3-wire / Δ 230VAC

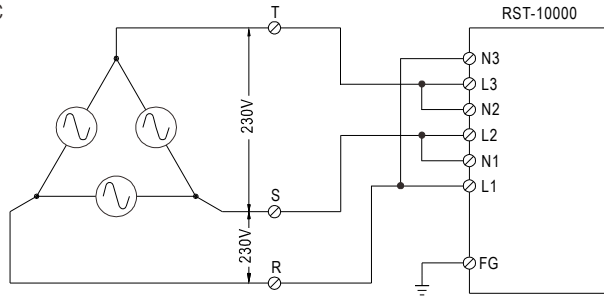

Fig 9.1

©3 ϕ 4-wire / Y 400VAC

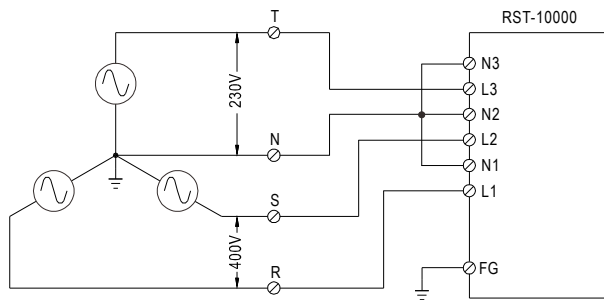
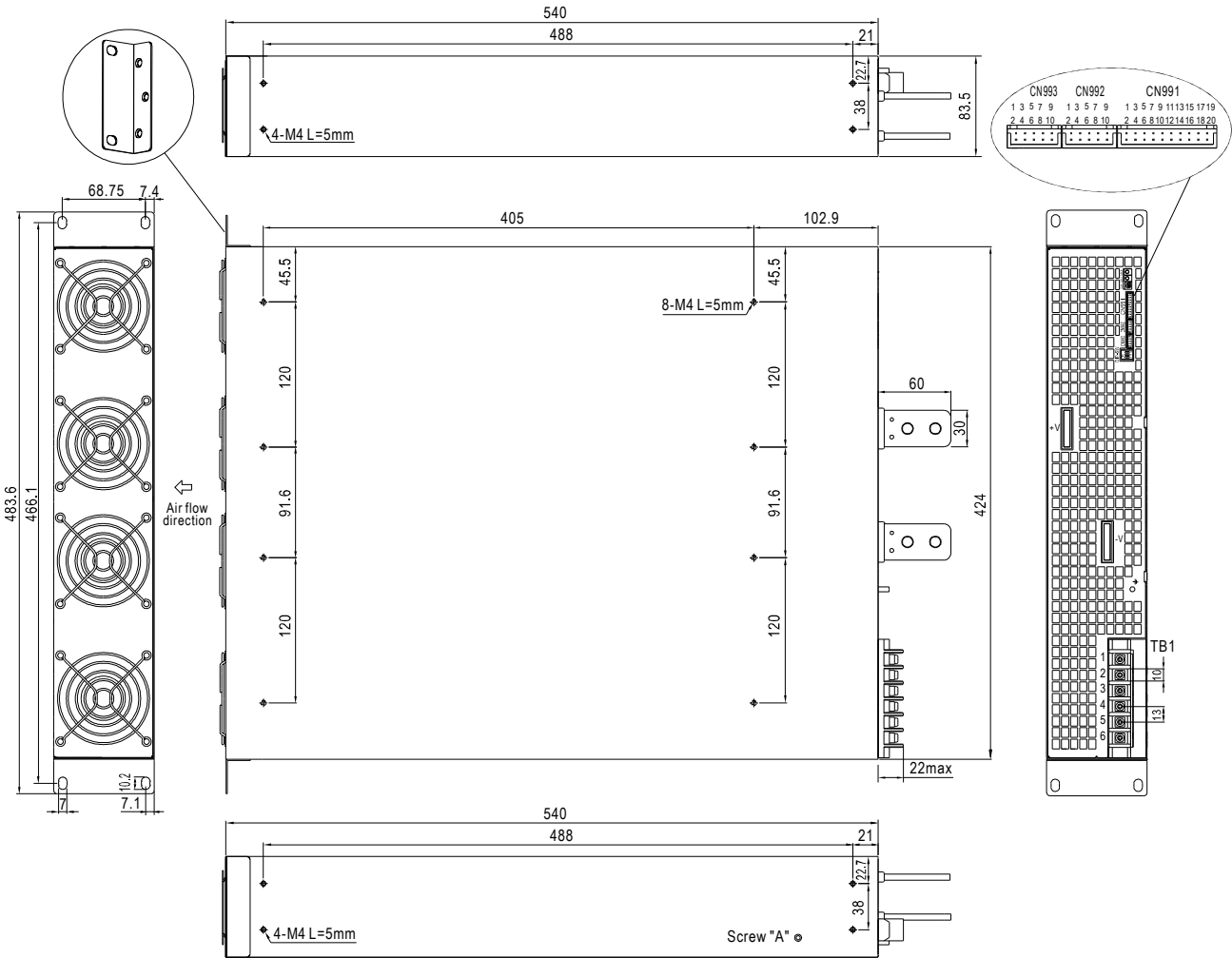

Fig 9.2

Mechanical Specification

Case No.234A Unit:mm



Terminal Pin No. Assignment

| Pin No. | Assignment | Pin No. | Assignment |
|---------|------------|---------|------------|
| 1 | AC/L1 | 4 | AC/N2 |
| 2 | AC/N1 | 5 | AC/L3 |
| 3 | AC/L2 | 6 | AC/N3 |

Control Pin No. Assignment(CN992,CN993) : HRS DF11-10DP-2DS or equivalent

| Pin No. | Assignment | Pin No. | Assignment | Mating Housing | Terminal |
|---------|------------|---------|------------|--------------------------------|--------------------------------|
| 1 | CS- | 6 | PV+ | HRS DF11-10DS or equivalent | HRS DF11-**SC or equivalent |
| 2 | CS+ | 7 | PC- | | |
| 3 | +S | 8 | RC- | | |
| 4 | PV- | 9 | PC+ | | |
| 5 | -S | 10 | RC+ | | |

Control Pin No. Assignment(CN991) : HRS DF11-20DP-2DS or equivalent

| Pin No. | Assignment | Pin No. | Assignment | Pin No. | Assignment | Pin No. | Assignment | Mating Housing | Terminal |
|---------|------------|---------|--------------|---------|---------------|---------|---------------|--------------------------------|--------------------------------|
| 1 | 12V-AUX | 6 | AC-FAIL2-GND | 11 | OTP2-GND | 16 | DC-OK1-GND | HRS DF11-20DS or equivalent | HRS DF11-**SC or equivalent |
| 2 | DC-OK2-GND | 7 | -V | 12 | FAN-FAIL2-GND | 17 | AC-FAIL1-GND | | |
| 3 | GND-AUX | 8 | AC-FAIL2 | 13 | OTP1 | 18 | FAN-FAIL1-GND | | |
| 4 | DC-OK2 | 9 | OTP2 | 14 | DC-OK1 | 19 | AC-FAIL1 | | |
| 5 | +V | 10 | FAN-FAIL2 | 15 | OTP1-GND | 20 | FAN-FAIL1 | | |

DIP Switch Position Assignment(DIP-SW): Please refer to the Function Manual.

| Position | Assignment | Position | Assignment |
|----------|------------|----------|------------|
| 1 | OLP mode | 3 | PV mode |
| 2 | PC mode | | |





C/ NAVA Nº 7 BAJO
33207 GIJON (ASTURIAS)
TFNO 985 319171 FAX 985 346795
Email: amv@amvelectronica.com

www.amvelectronica.com

GARANTIA

TODOS LOS EQUIPOS FABRICADOS POR **AMV ELECTRÓNICA** SALEN DE NUESTROS TALLERES AJUSTADOS, NUMERADOS Y CON DOCUMENTACIÓN TÉCNICA, **SIENDO LA GARANTIA TOTAL DE 5 AÑOS.**

LA GARANTÍA CUBRE LAS SITUACIONES DE DAÑO INTRÍNSECO, Y NO LAS PROVOCADAS POR CAUSAS EXTERNAS O LA MANIPULACIÓN POR PARTE DEL USUARIO.

LA GARANTÍA SE ENTIENDE EN NUESTROS TALLERES, SIENDO POR CUENTA DEL USUARIO LOS COSTES DEL TRANSPORTE.

AMV ELECTRONICA

TELEFONOS & E-MAIL DE CONTACTO

| DEPARTAMENTO | RESPONSABLE | Teléfono | e-MAIL |
|--------------------------------|-----------------|-------------------|--|
| Comercial y Ventas | Gracia Nomparte | 985319171 Ext. 10 | gracia@amvelectronica.com |
| Ingeniería | Víctor Viña | 985319171 Ext. 18 | |
| Producción | Jenaro Blanco | | compras@amvelectronica.com |
| Servicio de Asistencia Técnica | Alejandro Arce | 985319171 Ext. 17 | sat@amvelectronica.com |
| Administración | Laura Granda | 985319171 Ext. 12 | administracion@amvelectronica.com |